

**AUTOMATED MOTOR SHADE**

**1925 W. Copans Rd**

**Pompano Beach, FI 33064**

**PRICING FROM MURRAY'S BOOK - FOR MISC ITEMS WE SELL...**

**TEL: 954 974-0525**

**FAX: 954 974-0529**

EMAIL [murray@automatedmotorshade.com](mailto:murray@automatedmotorshade.com)

-12

revised

**T O :**

DATE

01/22/13

JOB

TEL

FAX



CEL







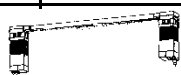

Contact

**E MAIL**

LOC

Disc

Part No.	Discription		Sketch				
<b>DRAPERY SYSTEM</b>				31-50 pcs	21-30 pcs	11-20 pcs	1-10 pcs
<b>CHINA MOTORS</b>							
D 200 P 50	30 Watt Drapery motor, 70 LB pull Mechanical Limits 12 N.cm	RS			111	117	144
D201 P 50	45 watt Motor 18 N.cm	RS			126	139	154
D 202P 50	<b>60 Watt Motor</b> 23 N.cm						
		<b>RSD 60A</b>		186	201	217	248
				31-50 pcs	21-30 pcs	11-20 pcs	1-10 pcs
D 203	45 Watt Drapery motor, 140LB pull		<b>220 VOLT</b>				154
	<b>BTX 30 watt Drape Motor</b>						362
	<b>BTX 45 watt Drape Motor</b>						438
D204	45 Watt <b>TANDEM</b> -Set .41 A						
D 205	60 Watt <b>TANDEM</b> .55 A						

											
	<b>TEST CORD</b>									30	
D 206	<i>AUTO-STOP Dis-Engaging Motor from RS Should only be used with TIMING BELT RS7950 A01 NO RF</i>										
	<i>AUTO-STOP Dis-Engaging Motor from RS Should only be used with TIMING BELT RS7950 B01 RF</i>								146	150	154
	<i>*ALL A-OK Controls work with this MOTOR</i>										
D 207	1-Function Trans OLD STYLE										37
<b>D 273</b>	1-Function Transmitter										17
<b>D 274</b>	8-function Transmitter										30
<b>DRAPE MOTOR M 750</b>											
D208 P 501	<b>M 750</b> _ 90 watt Motor Built in RF -										
					152	156	160	165	169		
					31-50 pcs	21-30 pcs	11-20 pcs	1-10 pcs			

D209 P 50	YR 2036 RF Hand Control 6- Function			17	17	18	18	18
D210	YR 1326 RF Hand Control 6- Function (MID STOP)							28

**AM 65 TOUCH PULL DRAPERY SYSTEM** see Line 190

	<b>AM65 2/80 AUTO RF</b>	100-240v					251
	<b>Low Volt Manual Wall Switch</b>						15
							1-10 Pc

D 214							
D 215							
D216							
D 217							
D 218							
D 219							
D 220							
D 221							



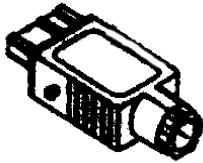



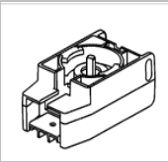
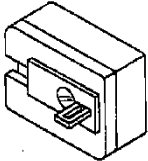
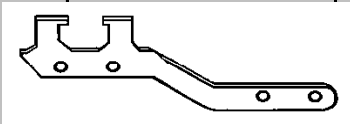
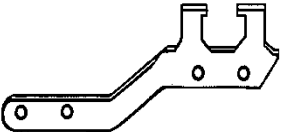
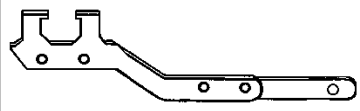
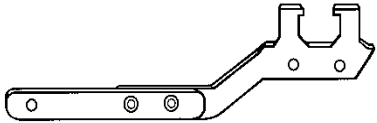

--	--	--	--	--	--	--	--

	<b>NOTE: Motor Plugs are Additional : Not Included with these</b>						
				* Now come with each motor we Purchase			
D 226	<b>Motor Plug 4-wire</b>						8.09
D 227	6- wire						



*\*Plugs now come with Motors, but cables may have to be changed ( reason-China Wire COLORS )*

				31-50 pcs	21-30 pcs	11-20 pcs	1-10 pcs
--	--	--	--	--------------	--------------	-----------	-------------

D 101	MAIN Drive		Sprocket	8.00	8.00	9.00	10.00
D 102	Idler END		Sprocket	7.96	8.37	9.18	10.20
<b>MOTOR DRIVE- White OLD Style ROUND Body from BTX</b>				<b>Sell OFF</b>		<b>5.00</b>	
<b>IDLER END_ OLD STYLE Gray from BTX</b>				<b>Sell OFF</b>		<b>5.00</b>	
D 103 L	Drive Runner, Left, Bracket + 2 clips		Sprocket	4.20	4.42	4.85	5.39
D 228	Drive Runner, Right, Bracket + 2 clips		Sprocket				3.28
D 229	Drive Runner, Left MASTER, w/extension		Sprocket	3.15	3.31	3.64	4.04
D 231	Drive Runner, Right MASTER, w/extension		Sprocket				





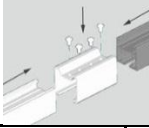
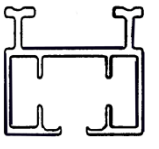
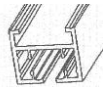
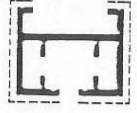
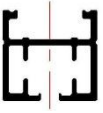



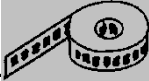

							
D 230	BIG TACKLE(Master - Heavy Duty/ Rev)	Sprocket		3.15	3.31	3.64	4.04
D 233	<b>CLUTCH TACKLE</b> Disengaging MAST	Sprocket					8.40
D 232	Connecting Apparatus (req 2 / runner)	Sprocket		#511413	<b>NO SOLD SEPARATE</b>		
	Connecting Apparatus (requires 2 per drive runner)						0.45
D 234	Belt Connectors	Sprocket					
D 235	Wall Bracket 2 7/8" S	P 218					
<b>D 272</b>	Wall Bkt 2 7/8 x 1 1/2 with Screws (no clip)						1.00
	DOUBLE 4.25" White						1.60
D 236	Wall Bracket 3" V	P 219					
D 238	Wall Bracket 4" V	P 220					
D 239	STEEL Wall Bkts 4" AG-40						
D 240	STEEL Wall Bkts 6"x8" AG-68/ WHITE						<b>1.815</b>

					3k	3K	11k	500
P 228	Light Duty Drapery Carriers	No Stock					0.31	0.31
P 229	Heavy Duty Drape Carrier NON-Swivel	500		0.39	0.41	0.45	0.5	
D 241	#511419 QUIET RUNNER *NG they chang							
				31-50 pcs	21-30 pcs	11-20 pcs	1-10 pcs	
D 115	Fixer - PLASTIC	20		2.75	2.89	3.17	3.53	
D 241	Fixer - METAL			0.45	0.47	0.52	0.58	
D 242	Motor Top Gear with Colar							45
D 243	Motor Top Plate							5.00
D 244	Sliding Lock							0.75
D 245	Motor Limit Assembly -(Plug-in LIMIT ASSEMBLY)							
D246	Motor BOTTOM HOUSING							
D 247	plug lock							

D 248	Drape Return						
D 250	#511418 Track SPLICE METAL			6.61	6.95	7.62	8.47
D 251	Rail Splice Fiberglass			2.65	2.79	3.06	3.40
D 253	Rail Splice (Covers both Rails for Support)	RSTS				1.5	
D 249							
D 249							
	OLD TYPE Drape Rail- Have Dye Not Stocked						
D 254	BA Rail						
	Ft					3.08	/ Ft
		/ PC					
	RS Rail for TIMING BELT			10 pc to Bundle ea Pc = 24 ft	40 ft		/ Ft ?
				BUNDLE ( 10 Pcs)			? ?
RIPPLEFOLD							
D 255	Swivel Snap Pendant for Ripplefold	9-345					0.25
D 256	80% 2 3/8" spacing	9-381					1.66

D 257	100%	2 1/8" spacing	9-382					1.66
D 258	120%	1 7/8" Spacing	9-395					1.66



	METAL SNAPS on Masters						0.15
				20+	10+	5+	1
D 104	Drive Belt 328'/roll (10-15-09) SPROCKET BELT		130	193	203	219	229 Disc
			Broken pcs				1.66 Disc
	<b>BTX SPROCKET BELT</b>						4.35
<b>TIMING BELT PARTS</b>				31-50 pcs	21-30 pcs	11-20 pcs	1-10 pcs
RS323204	Motor Drive		TIMING				8.01
RS323205	Idler		TIMING				8.00
RS323206	Masters - SMALL		TIMING				5.24
RS323206	Masters - LARGE						5.54
	MASTER for CURVE						
RS323208	Cager or Fixer			0.45	0.47	0.52	0.58
P 228	Light Duty Drapery Carriers (DO NOT S		200	 NOT STOCKED			
				3k	3K	11k	500
RS243201	HD Carrier			0.39	0.41	0.45	0.5



<b>"QUIET" DRAPERY SYSTEM M-750</b>				31-50 pcs	21-30 pcs	11-20 pcs
P 503	Motor M750		<b>* SEE ABOVE</b>			
P 504	YR 2036 RF Hand Control 6-Function		<b>* SEE ABOVE</b>			
D 260	Rail					
D 261	Motor Drive					
D 262	IDLER End					
D 263	Carriers - LT Duty					
D 264	Carriers - HEAVY Duty					
D 265	Sprocket BELT					
D 266	TIMING BELT					
D 267	LEFT- Master SMALL					
D 268	RIGHT- Master SMALL					
D 269	LEFT- Master LARGE					
D 270	RIGHT- Master LARGE					

<b>AM 65 TOUCH PULL DRAPERY SYSTEM</b>			31-50 pcs	21-30 pcs	11-20 pcs	1-10 pcs
--	--	--	-----------	-----------	-----------	----------

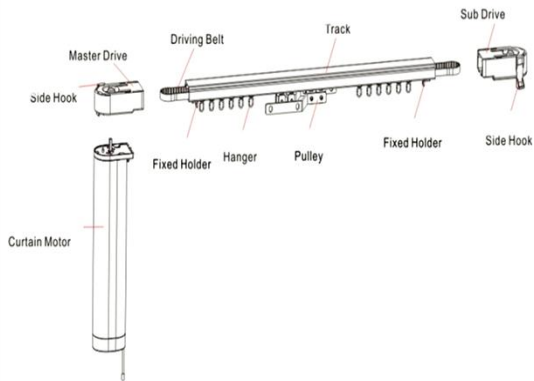



<b>AC MOTOR</b>					
<b>AM65 1/80</b>	110 ac				
<b>AM65 2/80 AUTO RF</b>	100-24	<b>237</b>	<b>262</b>	275	276

**TRANSMITTER**

<b>AC114-1</b>	<b>1-function</b>	<b>20</b>	<b>22</b>	25	27
<b>AC114-2</b>					
<b>AC114-6</b>	<b>6- function</b>	<b>24</b>	<b>26</b>	29	32
<b>AC114-16</b>	<b>16-function</b>	<b>37</b>	<b>41</b>	45	50
<b>AC 112-04</b>	<b>Low Voltage Manual Wall Switch</b>				15







?	<b>Drive</b>	<b>RAEX</b>	7	8	9	10

<b>#025340</b>	<b>DRIVE / IDLE</b>	  	<b>7.4</b>	<b>8.12</b>	<b>9.02</b>	<b>9.92</b>
----------------	---------------------	---	------------	-------------	-------------	-------------

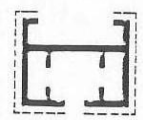
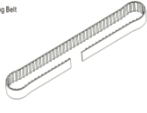
	<b>Idler</b>				
--	--------------	--	--	--	--

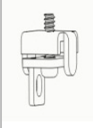
	<b>CARRIER</b>		<b>0.3</b>	<b>0.33</b>	<b>0.37</b>	<b>0.41</b>
--	----------------	---	------------	-------------	-------------	-------------

	<b>RAIL</b>	 	<b>6.22</b>	<b>6.83</b>	<b>7.59</b>	<b>8.34</b> ?
--	-------------	---	-------------	-------------	-------------	---------------

RAIL S-70						3.08	
BELT - "Timing"		 12mm	1.33	1.46	1.63	1.79	
Drive		RAEX					
Idler							
Master RT			4.03	4.43	4.92	5.41	
Master LG							
Cager-METAL			0.67	0.74	0.82	0.9	
Ceiling Clip ( Spring Loaded)			2.02	2.21	2.46	2.71	
SPLICE - Over Rail			4.03	4.43	4.92	5.41	
SPLICE_ Insert			5.04	5.54	6.15	6.77	
<b>Bending Machine</b>						5000	
220 3-phase			change over to 220 3-phase				

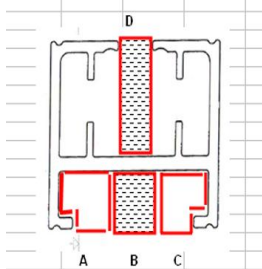
	Plastic Die for bending machine (per set of 3 ) 1 set included with machine			
	additional to put 4- caser wheels on base of Bending machine			
	Freight & Duty is Additional.. We have shipped Directly			
	Rail Bender INSERTS 4 pcs in 4 ft sections	per section	50.00	
				
<b>BTX PARTS Equal</b>				
	30 watt Motor UL			
	45 watt Motor UL			

CLASS Fabricator Pricing			
Timing			
Part #	Description	Pk Unit	List Cost USD
236.1860	Bracket Assembly, Wall	20	6.71
248.3500	Rail Coupling, Aluminum	10	2.28
240.7140	Runner w/Turnable Grommet	1000	0.60
240.7040	Runner, Fixed, Heavy Duty	500	0.60
246.9000	Drive Runner Block	100	1.30
240.8050	Cager	100	1.08
238.2045	Bayonet Cap, Grey	25	1.87
238.2060	Bayonet Cap, White	25	1.87
256.3000	Planetary Gear	10	7.20
236.1300	Ceiling Bracket	100	1.40
Part #	Description	Pk Unit	List Cost USD
290.2000	Timing Belt, 656yd roll	\$2.12/ Ft	656 9.94
		by roll	6,521
		Cut	3.64

290.2109	<b>SPROCKET BELT</b>	per will	
	100 Meter Roll		
	109 Yds		2,175 / Roll
	Per yd		19.95 / yd
	Per Ft Broken		7.30
266.4900	Drive Runner, Traversing Joint, Rt	25	12.80

266.4950	Drive Runner, Traversing Joint, Lt	25	12.80
256.1030	Gear, Drive Timing Belt, Classic, White	10	43.00
256.1035	Gear, Drive Timing Belt, Classic, Grey	10	43.00
254.1045	Fabric Clip, Grey	10	1.03
254.1060	Fabric Clip, White	10	1.03
256.1545	Non-Drive Gear End, 5060 Classic, Grey	10	10.58
256.1560	Non-Drive Gear End, 5060 Classic, White	10	10.58
246.0600	Safety Clip	100	0.60
310.5560	Headrail, 5060, White, 23'	20	4.20
310.5510	Headrail, 5060, Anod. Alu., 23'	20	4.20
272.6000	Snap Pendant	1000	0.22
270.1025	LH Overlap Arm, Ripple Style*	10	6.00
270.1075	RH Overlap Arm, Ripple Style*	10	6.00
266.1700	LH Butt Master, Ripple Style*	10	4.26
266.1750	RH Butt Master, Ripple Style*	10	4.26
240.0800	Ripple Style Carrier, 80%*	1000	1.05
240.1000	Ripple Style Carrier, 100%*	1000	1.05
240.1900	Accordia Style Carriers*	1000	1.05
240.1200	Ripple Style Carrier, 120%*	1000	1.05
	<b>5060 Classic Motor Assemblies BTX</b>		
570.0030	Mtr, 30W, Classic 110V	5	361
570.0045	Mtr, 45W, Classic, 110V	5	438
	Mtr, 60W, Classic, 110V		
570.3030	Mtr, 30W Tan Drive, Classic, 110V	5	394
570.3031	Mtr, 30W Tan Non-Drive, Classic, 110V	5	309
570.3045	Mtr, 45W Tan Drive, Classic, 110V	5	430
570.3046	Mtr, 45W Non-Drive, Classic, 110V	5	345

\*Accordiafold/Ripplefold is a trade mark of Kirsch;  
BTX utilizes Graber Roll Pleat due to the fact that it rolls better in the tracks.

**All Prices are FOB Factory-Dallas, Texas.**

**All Prices subject to change without prior notice.**

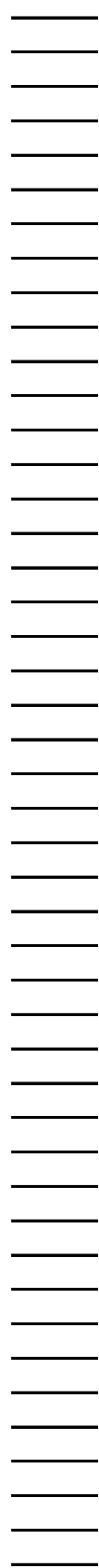





RA2	2.0 Adapter (Convert 40mm to 2")	Each			



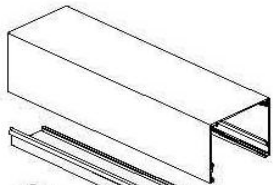

### 40mm SHADE PARTS

	motor #404 S2			
	motor drive			
	COLAR Adaptor			
	Motor AM35 6-28 STD			
	Motor AM35 6-28 "E"			
	40mm Round Drive			
	STAR-END on Motor 			
	Rollease Plastic End 			9.36
	Motor Brackets 			
	RB 360			
	RB 380			

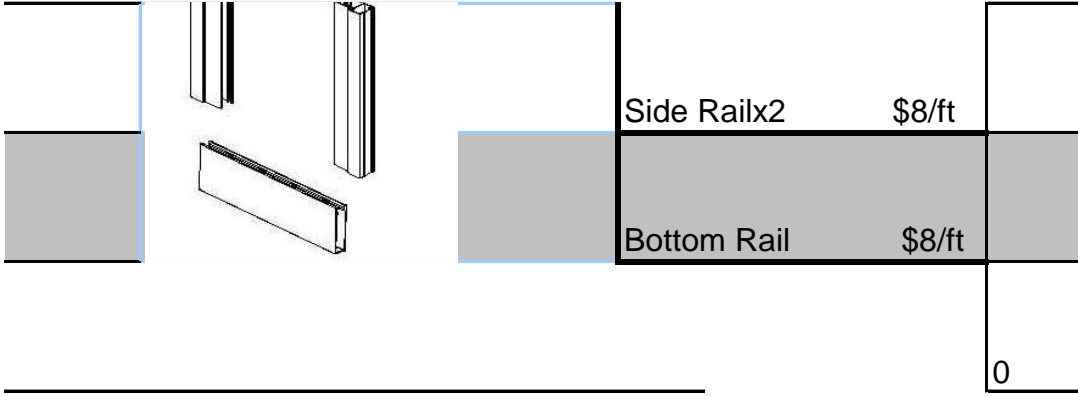
### FACIA PRICES

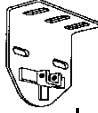
	Facia Only	\$12/ft 0
	Facia Cvr	\$12/ft
	Bkts / Pr	15

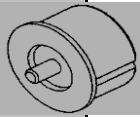
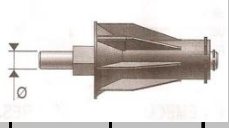
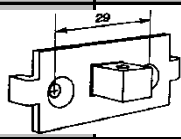

				31-50 pcs	21-30 pcs	11-20 pcs	1-10 pcs
motor Bkt 2"		Std	#9410665				4.94
Idler Bkt 2"		10mm	#9410635				5.18
plastic end cap		Std	#9700958				2.65
END CAP- Metal			#				
"STAR" Motor Bkt			#9410651				6.13
SONESSE LT 50 Quite #504 S2 RTSS 1039965							274.43
P 221	Plastic END		#9700958				3.94
P 222	Collapsible 10mm END CAP		#9420800				7.1625
P 223	PH- Pin - SOMFY Motor						7.05
P 225	Motor Drive-Somfy		#9206088		2.32		1.74

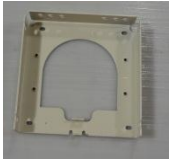
P 450	FACIA BRACKETS 4" for 2" tube (Adjustable Idler) White-Silver- Black- Bronze		DISC 8/12	\$25
P 452	FACIA BRACKET 4" Adjustable IDLER END			\$27
P 451	Facia Bkt 4" Intermedicate with Cutout			10

white Silver Vanilia Bronze Black



P 453	FACIA- 4" with Center Support					
P 454	FACIA- 4" with UNIVERSAL for 2.o tube					



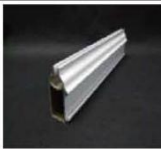

<b>TUBING</b>				CASE		
P 230	2" Tube Alum White	24 ft Length				56.16
P 231	2" Tube Steel	20 ft Length				75.00
P 400	2" Alum Tube Clear Finish	16 ft				23.04
P 219	2.0 Tube HD AL Tube 5OS Super HD 5	19.2' 192'/Cs				6.20
P 232	40mm Alum Tube White	24 ft L 5/08	*see Cost			73.37
				1k Lbs Min		3.06
P 217	40mm Tube w/Tape	19.2 ft ea 1	AL-Tube 04 HDT			2.55
P 233	1" Tube	28mm				
P 234	3" ALUM TUBE	24 ft Length				274
P 235	CROWNS = 2					
P 236	Drives = 1					
P 229	40mm Octogon Tube	20 ft Length				

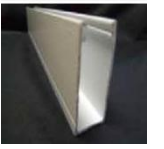

P 218	Fluted Tube- Arabel for 40mm D		20pc/case 1	Tape		17
	Paer # RS-AT1 11/2-16			NO tape		16

**SHADE HARDWARE & SIDE CHANNELS**

P 400	<b>4" ALUMINUM FASCIA</b> LENGTH: 16 ft  COLORS: white, Ivory, Bronze, Anodized & Black		10 pcs per carton	160 ft per box		
P 401	<b>ELITE BOTTON RAIL</b> LENGTH: 16 ft  COLORS: white, Ivory, Bronze, Anodized & Black		24 Pcs per Carton	384 ft per Box		
P 402	<b>PLASTIC END CAPS</b>		500 per box			

	for ELITE Aluminum Bottom Rail				
	COLORS: white, Ivory, Bronze, Anodized & Black				
P 403	<b>ALUMINUM SIDE CHANNEL</b> LENGTH 16 ft		16 pcs Per Bundle	256 ft per Bundle	
	COLORS: white, Ivory, Bronze, Anodized & Black				
P 404	<b>ALUMINUM FLAT HEM BAR</b> LENGTH 16 ft		50 pcs per Bundle	800 ft per Bundle	
	PART: RS-AFHB-16				
P 505	<b>PLASTIC Insert for ELITE Bottom Rail</b> LENGTH 10 ft		50 pcs per Bundle	500 ft per Bundle	
					
P 506	<b>FELT for SIDE CHANNEL</b> PART # RS-FSC		990 Ft per Roll		
					
P 507	<b>ALUMINUM TUBE 1 1/4" Type "A"</b> LENGTH 16 ft PART: RS- AT 11/4-16 28 mm		20 pcs Per Bundle	320 ft Per Bundle	
					
P 508	<b>ALUMINUM TUBE 1 1/2" Type "B"</b> LENGTH 16 ft PART: RS- AT 11/2-16 38 mm		20 pcs Per Bundle	320 ft Per Bundle	

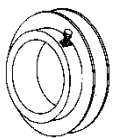
							
P 509	<b>ALUMINUM TUBE</b> LENGTH 16 ft	<b>2" Type "B"</b> PART: RS- AT 2 50 mm		12 pcs Per Bundle	192 ft Per Bundle		
							
P 510	<b>ALUMINUM TUBE</b> LENGTH 16 ft	<b>2" SMOOTH TUBE</b> PART: RS- AT 2S-16 50 mm		12 pcs Per Bundle	192 ft Per Bundle		
							
P 605	<b>ALUMINUM TUBE</b> LENGTH 16 ft	<b>2" GROOVED TUBE</b> PART: 50 mm		12 pcs Per Bundle	192 ft Per Bundle		
							
P 606	<b>ALUMINUM TUBE</b> LENGTH 16 ft	<b>2.5" GROOVED TUBE</b> PART: RS-AT21/2G-16 63 mm		8 pcs Per Bundle	96 ft Per Bundle		
							
<b>ADAPTORS NECESSARY FOR SOMFY MOTOR</b>							
	COLAR						
	MOTOR DRIVE						
	IDLER						
<b>SHADE CLIPS</b>							
					401-600	200-400	1-199
P 226	<b>Fabric Clip</b>	<b>28mm (1" tube)</b>					0.80

P 204	1 1/4"	200/Cs					
P 203	Fabric Clip 1 1/2" 40mm	200/Cs				0.61	0.62 0.64
P 202	Fabric Clips 2" 50mm	200/Cs				0.65	0.66 0.68
P 200 A	Lift Spool 1/4"						
P 227	Lift Spool 1/8"						
P 228	Lift Tape 1/4" 550 yds #367 White			.20/ ft loose			
P 229	Lift Tape 1/8" 1000 yd Roll						
P 237	NON Stretch Cord 100m	Roll					
P 238	6" Poly Tubing 3.5Mil 15#/Roll						
P 239	10" Poly Tubing 3.5Mil 15#/Roll						
P 240	Lift Line Lock-Clear for Romans #0262-02 27000						0.6
P 241	Roman-Bar Bottom Ring Set #0-161-01-15000 .9mm cord						0.84

**CIERA**

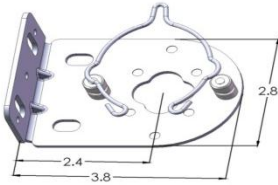
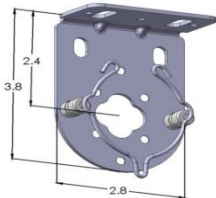
Picture	Part #	Description
	BMSWM	<b>Bracket Motor Short Wall Mount</b> Motor Bracket for LT50 Star Head Motors Zinc plated steel Maximum weight capacity - 40LB Max Roll Ø 4 1/8"
	BMSCM	<b>Bracket Motor Short Ceiling Mount</b> Motor Bracket for LT50 Star Head Motors Zinc plated steel Maximum weight capacity - 40LB Max Roll Ø 4 1/8" Stainless steel screws



	BIS	<b>Bracket Idler Short</b>
		Idler Bracket for LT50 Star Head Motors
		Zinc plated steel and Delrin
		Stainless steel screws
		Maximum weight capacity - 40LB
		Max Roll $\varnothing$ 4 1/8"

	CI2I	<b>Collapsible idler 2 inch</b>
		Works with notched 2 inch tube and tubes with internal key
		Black Composite Housing
		Maximum weight capacity - 40LB
		Zinc plated steel Shaft



	CBAS	<b>Coupling Bracket Assy Short</b>
		Works with notched 2 inch tube and tubes with internal key
		Zinc plated steel
		Black Composite Housing
		Maximum weight capacity - 40LB
		Max Roll $\varnothing$ 4 1/8"

	ACBAL-WM-R (right shown) ACBAL-WM-L (left)	<b>Adjustable Coupling Bracket Assy Long - Wall Mount</b>
		Works with notched 2 inch tube and tubes with internal key
		Zinc plated steel bracket
		Black Nylon Housing
		1/2" height adjustability
		Maximum weight capacity - 40LB
		Max Roll $\varnothing$ 6 3/4"

	AIBAS-CM	<b>Adjustable Idler Bracket Assy Short Ceiling Mount</b>
		Works with notched 2 inch tube and tubes with internal key
		Zinc plated steel bracket
		Black Nylon Housing
		1/2" height adjustability
		Maximum weight capacity - 40LB
		Max Roll $\varnothing$ 4 1/8"

	AIBAS-WM-R (right shown) AIBAS-WM-L (left)	<b>Adjustable Idler Bracket Assy Short Wall Mount</b>
		Works with notched 2 inch tube and tubes with internal key
		Zinc plated steel bracket
		Black Nylon Housing
		1/2" height adjustability
		Maximum weight capacity - 40LB
		Max Roll $\varnothing$ 4 1/8"

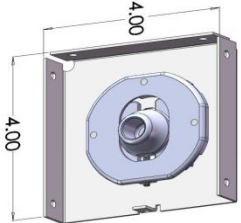

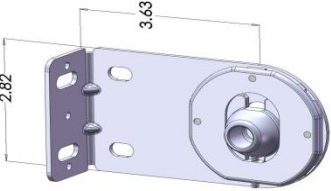
	<p style="text-align: center;"><b>AIBBA</b></p>	<table border="1"> <tr><td><b>Adjustable Idler Box Bracket Assy</b></td></tr> <tr><td>Works with notched 2 inch tube and tubes with internal key</td></tr> <tr><td>Powder coated 4 inch steel box bracket</td></tr> <tr><td>Black Nylon Housing</td></tr> <tr><td>1/2" height adjustability</td></tr> <tr><td>Maximum weight capacity - 40LB</td></tr> <tr><td>Max Roll <math>\varnothing</math> 3 3/4"</td></tr> </table>	<b>Adjustable Idler Box Bracket Assy</b>	Works with notched 2 inch tube and tubes with internal key	Powder coated 4 inch steel box bracket	Black Nylon Housing	1/2" height adjustability	Maximum weight capacity - 40LB	Max Roll $\varnothing$ 3 3/4"
<b>Adjustable Idler Box Bracket Assy</b>									
Works with notched 2 inch tube and tubes with internal key									
Powder coated 4 inch steel box bracket									
Black Nylon Housing									
1/2" height adjustability									
Maximum weight capacity - 40LB									
Max Roll $\varnothing$ 3 3/4"									
	<p style="text-align: center;"><b>AIBAL-CM</b></p>	<table border="1"> <tr><td><b>Adjustable Idler Bracket Assy Long Ceiling Mount</b></td></tr> <tr><td>Works with notched 2 inch tube and tubes with internal key</td></tr> <tr><td>Zinc plated steel bracket</td></tr> <tr><td>Black Nylon Housing</td></tr> <tr><td>1/2" height adjustability</td></tr> <tr><td>Maximum weight capacity - 40LB</td></tr> <tr><td>Max Roll <math>\varnothing</math> 6 3/4"</td></tr> </table>	<b>Adjustable Idler Bracket Assy Long Ceiling Mount</b>	Works with notched 2 inch tube and tubes with internal key	Zinc plated steel bracket	Black Nylon Housing	1/2" height adjustability	Maximum weight capacity - 40LB	Max Roll $\varnothing$ 6 3/4"
<b>Adjustable Idler Bracket Assy Long Ceiling Mount</b>									
Works with notched 2 inch tube and tubes with internal key									
Zinc plated steel bracket									
Black Nylon Housing									
1/2" height adjustability									
Maximum weight capacity - 40LB									
Max Roll $\varnothing$ 6 3/4"									
	<p style="text-align: center;"><b>AIBAL-WM-R (right shown) AIBAL-WM-L (left)</b></p>	<table border="1"> <tr><td><b>Adjustable Idler Bracket Assy Long Wall Mount</b></td></tr> <tr><td>Works with notched 2 inch tube and tubes with internal key</td></tr> <tr><td>Zinc plated steel bracket</td></tr> <tr><td>Black Nylon Housing</td></tr> <tr><td>1/2" height adjustability</td></tr> <tr><td>Maximum weight capacity - 40LB</td></tr> <tr><td>Max Roll <math>\varnothing</math> 6 3/4"</td></tr> </table>	<b>Adjustable Idler Bracket Assy Long Wall Mount</b>	Works with notched 2 inch tube and tubes with internal key	Zinc plated steel bracket	Black Nylon Housing	1/2" height adjustability	Maximum weight capacity - 40LB	Max Roll $\varnothing$ 6 3/4"
<b>Adjustable Idler Bracket Assy Long Wall Mount</b>									
Works with notched 2 inch tube and tubes with internal key									
Zinc plated steel bracket									
Black Nylon Housing									
1/2" height adjustability									
Maximum weight capacity - 40LB									
Max Roll $\varnothing$ 6 3/4"									

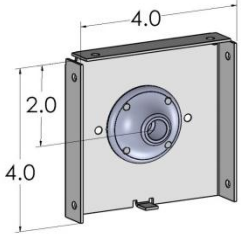
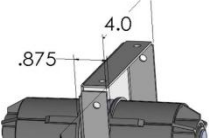
	<p style="text-align: center;"><b>IBBA</b></p>	<table border="1"> <tr><td><b>Idler Box Bracket Assembly</b></td></tr> <tr><td>Idler Bracket for LT50 Star Head Motors</td></tr> <tr><td>Powder coated 4 inch steel box bracket</td></tr> <tr><td>Stainless steel screws and Delrin nest</td></tr> <tr><td>Maximum weight capacity - 40LB</td></tr> <tr><td>Max Roll <math>\varnothing</math> 3 3/4"</td></tr> </table>	<b>Idler Box Bracket Assembly</b>	Idler Bracket for LT50 Star Head Motors	Powder coated 4 inch steel box bracket	Stainless steel screws and Delrin nest	Maximum weight capacity - 40LB	Max Roll $\varnothing$ 3 3/4"
<b>Idler Box Bracket Assembly</b>								
Idler Bracket for LT50 Star Head Motors								
Powder coated 4 inch steel box bracket								
Stainless steel screws and Delrin nest								
Maximum weight capacity - 40LB								
Max Roll $\varnothing$ 3 3/4"								
	<p style="text-align: center;"><b>CBBA</b></p>	<table border="1"> <tr><td><b>Coupling Box Bracket Assy</b></td></tr> <tr><td>Works with notched 2 inch tube and tubes with internal key</td></tr> <tr><td>Powder coated 4 inch steel box bracket</td></tr> </table>	<b>Coupling Box Bracket Assy</b>	Works with notched 2 inch tube and tubes with internal key	Powder coated 4 inch steel box bracket			
<b>Coupling Box Bracket Assy</b>								
Works with notched 2 inch tube and tubes with internal key								
Powder coated 4 inch steel box bracket								

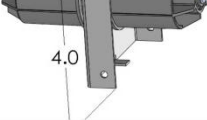
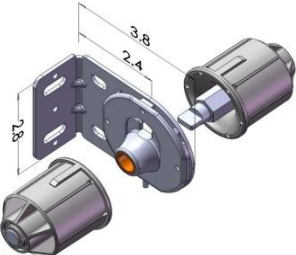
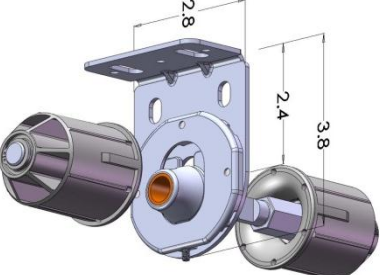
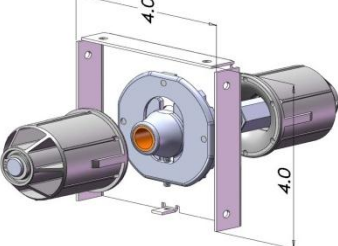
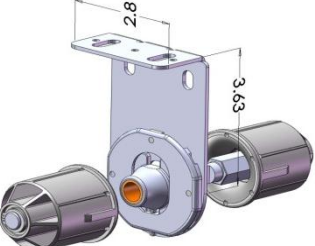
		Black Nylon Housing Maximum weight capacity - 40LB Max Roll $\varnothing$ 3 3/4"
	ACBAS-WM-R (right shown) ACBAS-WM-L (left)	<b>Adjustable Coupling Bracket Assy Short Wall Mount</b> Works with notched 2 inch tube and tubes with internal key Zinc plated steel bracket Black Nylon Housing 1/2" height adjustability Maximum weight capacity - 40LB Max Roll $\varnothing$ 3 7/8"
	ACBAS-CM	<b>Adjustable Coupling Bracket Assy Short Ceiling Mount</b> Works with notched 2 inch tube and tubes with internal key Zinc plated steel bracket Black Nylon Housing 1/2" height adjustability Maximum weight capacity - 40LB Max Roll $\varnothing$ 3 7/8"
	ACBBA	<b>Adjustable Coupling Box Bracket Assy</b> Works with notched 2 inch tube and tubes with internal key Powder coated 4 inch steel box bracket Black Nylon Housing 1/2" height adjustability Maximum weight capacity - 40LB Max Roll $\varnothing$ 3 3/4"
	ACBAL-CM	<b>Adjustable Coupling Bracket Assy Long - Ceiling Mount</b> Works with notched 2 inch tube and tubes with internal key Zinc plated steel bracket Black Nylon Housing 1/2" height adjustability Maximum weight capacity - 40LB Max Roll $\varnothing$ 6 3/4"

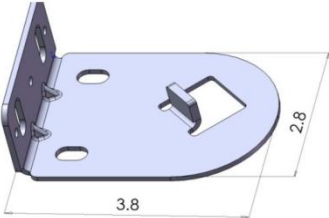
	BR24S	<b>Bracket R24 Short</b> Works with R24 Clutch Zinc plated steel Max Roll $\varnothing$ 4 1/8" Maximum weight capacity - 40LB
---	-------	---

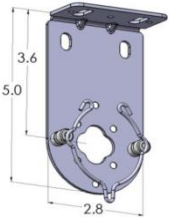
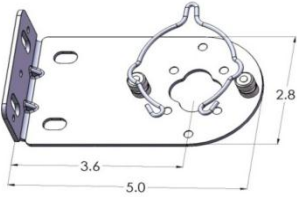
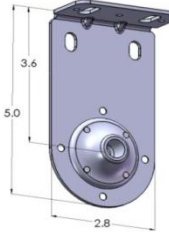
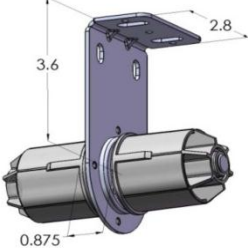
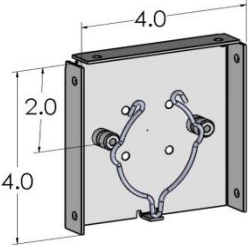





	<b>BMLCM</b>	<b>Bracket Motor Long Ceiling Mount</b>
Motor Bracket for LT50 Star Head Motors		
Zinc plated steel		
Stainless steel screws		
Maximum weight capacity - 40LB		
Max Roll Ø6 3/4"		
	<b>BMLWM</b>	<b>Bracket Motor Long Wall Mount</b>
Motor Bracket for LT50 Star Head Motors		
Zinc plated steel		
Stainless steel screws		
Maximum weight capacity - 40LB		
Max Roll Ø6 3/4"		
	<b>BIL</b>	<b>Bracket Idler Long</b>
Idler Bracket for LT50 Star Head Motors		
Zinc plated steel and Delrin		
Stainless steel screws		
Maximum weight capacity - 40LB		
Max Roll Ø 6 3/4"		
	<b>CBAL</b>	<b>Coupling Bracket Assy Long</b>
Works with notched 2 inch tube and tubes with internal key		
Zinc plated steel bracket		
Black Composite Housing		
Maximum weight capacity - 40LB		
Max Roll Ø 6 3/4"		
	<b>MBBA</b>	<b>Motor Box Bracket Assembly</b>
Motor Bracket for LT50 Star Head Motors		
Powder coated 4 inch steel box bracket		
Stainless steel screws		
Maximum weight capacity - 40LB		
Max Roll Ø 3 3/4"		





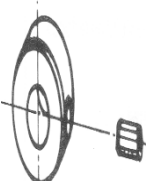

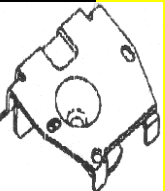
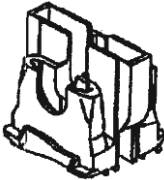

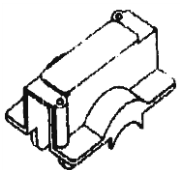
**ASSIGNMENT OF PART NUMBERS**



P 217	40mm Tube w/Tape 19.2 ft ea 10 pc/Cs 192ft					
P 218	Fluted Tube- Arabel for 40mm Dia 1.75"					
P 219	2.0 Tube HD AL Tube 5OS Super HD 50mm W-TAPE					
P 607						
P 608						

	M 851 Dbl Shaft	10Nm				180.0	210.0
	M 852 Dbl Shaft						
	7mm Hex shafts by Faber						2.00
<u>P 521</u>	Motor Pad/ Dbl Stick	6" x 2"					<b>4</b>

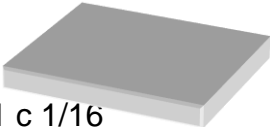
<b>PHASING OUT 2.4" HEAD RAIL SYSTEM &amp; PARTS</b>						<b>STOCK</b>	<b>EXT</b>
Rail	Beige #520	#2030010	5.97/Mtr	16 ft pcs		2.17	
Rail	White #609						
Rail	Silver #717						



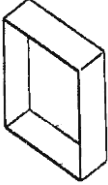

Rail	Bronze #639				
					4.11
P 516	Tilt Rod	7 mm 16 ft	# 20 76 7		1.77
P 515	Stop Ring		# 20 76 713		1.77
P 510	bracket/ Cam	to mount Rail	# 20 75 134		2.61
P 511	Tilt Rod Pulley		# 20 76 392		1.74
					
P 512	Tilt Rod cover		# 20 76 434		2.5
	Rod Bearing				1.35

					
	Lift Spool w/ RIBS 1/8" Tape				7
					7
					
	Seal for ladderbraided			20 78 014	.45 ea
	Misc Brad Clips				
	Pure lead wts BOTTOM WEIGHTS 6x1 c 1/16				2
	V- Roll			# 20 76 427	3.4



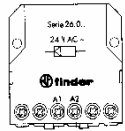

P 514	bearing - Ball Pulley		# 20 76 426			4.04	
	End caps		# 20 7			5.16	
	Universal Coupler		# 20 76 578			5.16	
	Std Coupler		# 20 76 197			3.96	
P 517	Lift Spool for 1/4" Duette tape #51018						
P 518	End Covers for 2.4" Rail						
P 519	RAIL 2.4" 16.5 ft Lenfths						
P 228	Lift Tape 1/4"						
	FABER RAIL PUNCH SET & TOOLS						0

<b>ELERO - MOTORS &amp; PARTS</b>				LIST	COST	SELL
1/	JA 06D Dbl shaft motor			331	198	308.00
2/	7mm Nex Connectors #16.300.1201			2.43	1.458	2.25
3/	Elero <b>Tube Motor</b> with RP BUILT IN	ITEC	<i>Phasing Out</i>	310	186	310.00
4/	Tube motor DRIVE 13105.5701			4.14	2.48	5.00
5/	16mm Pin 13107.0202			4.02	2.45	5.00
6/						
7/	AC Plug for motor ( Not Installed )					5.02
<b>* ALT IS M850 Dbl shaft</b>						200



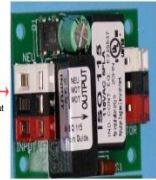





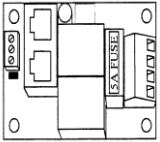

					STOCK	
E 233	Sequence Relay #2608 / 24	<b>Disc</b>				30
E 234	DT 1 1-button hand control	<b>Phasing Out</b>				70
E 235	DT 2					80
E 236	DT 4					100
E 237	DT 8-12 to be Disc					210
E 238	DR 1 Board Only	<b>Disc</b>				75
E 239	DR 2 Board Only					100
E 240	DR 4 Board Only					125
E 231	D-8C 8-function Board -Linear-					200
E 232	Transformer 24 V CP					30
E 241						
E 242	R1R Interface Board ONLY	<b>Disc</b>				
E 243	#705 Radio board for R1R					
E 244						
E 245						
E 246						
E 247						
E 248						

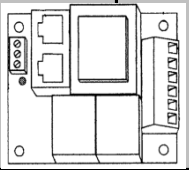



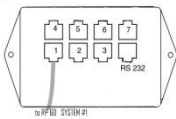

E 102	LNR-1 Linear compatible receiver Ctl ( BOARD ONLY }					
E 103	RP 60 AU ( BOARD ONLY }					
E 104	RP 60 DU ( BOARD ONLY }					



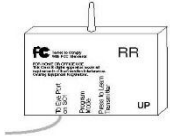

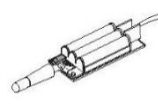

E 209	RP 60 AUM ( BOARD ONLY }						
E261	ISO Isolation Relaty for AC motor (Board ONLY						102
E 262	ISO-4 4-motor Isolation Relay (Board ONLY)						324
E 263	ISO-4 4-motor Isolation Relay 8x8x4 metal box						428
E 264	RP 60 AB Control in Box "Plug&Play"						
E 265	R2D7 RS-232 interface for serial Commands						
E 266	RS232 Adapter DB9 to RJ11 adapter for R2D7 interface						
E 267	SSPB-1 programable Sun Sensor. In						
	runs thru R2D7 unit as Add-on unit						
E 268	KEY Pad 24 button for Programing IR-Eye						
E 269	PC 6 power Cord						
E 270	AC Plug White- RIGHT ANGLE- WESPORT					5.02	
E 271							

## RS 232 INTERFACE INFORMATION

	RQ 60 AC		0	180.00	0		
	RQ60 DU		0	180.00	0		
	12V 100W Pwr 6 Amps		0	320.00	0		
	24V 100w Pwr 4 Amp		0	320.00	0		
	RP60		0	175.00	0		
	Snap TRACK 4 ft			98.00	0		
	RP60 ABMH-2		0	266.00	0		
	RP60 ABMH		0	237.00	0		
	POWER CORD PC10			11.00	0		

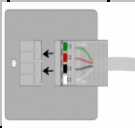
	POWER CORD PC20			15.00	0		
	ISO Relays			52.00	0		
	ISO-4			162.00	0		
	RP60 HDP Inter for HD PowerRise			0	93.00	0	
	R2D7		INTERFA	0	145.00	0	
	RQ Bridged			0	98.00	0	
	rs 232 ADAPTOR			0	10.00	0	
	T 24 IR only Hand Ctl			0	85.00	0	
	T24 DUAL Ctl-hand			0	180.00	0	

				0	18.00	0		
IR- EYE				0	18.00	0		
				0	83.00	0		
RR- RF Receiver				0	83.00	0		
				0	155.00	0		
K24 STWALL BUS KEY PAD				0	155.00	0		
				0	198.00	0		
WALL WIRELESS KEY PAD				0	198.00	0		
			Cable	0	50.00	0		
				0	59.00	0		
USB Adaptor				0	59.00	0		
				0	52.90	0		
RFTM			RF REC	0	52.90	0		
				0	25.30	0		
DCPM			Power S	0	25.30	0		
				0	160	0		
CONTROL BOX				0	160	0		

AC 117	AOK RS232 Interface			0	75	0		
	Program Disk			0	200	0		
						0		
E 202	MALE STAK-3 Hirschman Plug ONLY							10
E 203	FEMALE STAS-3 Hirschman Plug ONLY							10
E 219	<b>WEP</b> Wall Entry plate + motor plug (Sn 7/8 wall projection)							32
E 220	WAGO motor plug MALE/ on Ctl							15
E 221	WAGO motor plug FEMALE/on Motor							15
E 258	WAGO motor plug MALE/ on Ctl NEW GROUNDED Type							15
E 259	WAGO motor plug FEMALE/on Motor NEW Grounded type							16.56

*Phasing Out*

E 222	WAGO INSERT TOOL							0.30
	WEP-White NEW 1-Plug							35.00
	WEP-White NEW 2-Plug							64.00

**TEST & TOOLS**

E 204	Wire 18/4	500'	Roll		Broken = .85			216
E 205	Wire 20/6	500'	Roll		Broken = .85			216
E 206	4-wire Flat Telephone Cable							0.25
	6-wire Flat Telephone Cable							0.35

**ESI SHADE MOTORS**



**ESI - SHADE HARDWARE**

E 207	Tel Crimp		RJ-11 4- w 					0.36
	Tel Crimp		RJ-11 6- wire					
	Tel Crimp		RJ-22 "MINI"					
	Tel Crimp		RJ-45 6- wire					

E 211	Telephone Wire Crimp TOOL							
-------	---------------------------	--	--	--	--	--	--	--





E 212	LINE TRACER Toner&Sender					
E 213	LINE CHECKER Sender/Receiver					25
E 230	MOD 4-wire Cable Tester w/LEDs					5.18
E 208	Omron Relay MY-4					4.88
E 210	Omron Relay Socket MT 14 pc					3.50
E 214	Power cord 10' 18/3 3 wire Grounded					5
E 251	3-wire 18ga Plug Cord White 10 ft					15
E 223	Hirschman FEMALE TESTER w/ 2-lites					15
E 224	FLAT PLUG Tester w/ 2-lites					18

## DECORA SWITCHES

E 225	DECORA Switch Maintained W/SPDT					19.00
E 260	DECORA Switch Maintained W/DPDT					36.15
E 292	D1AA Amond					35
	DECORA Switch Maintained BLACK					35
E 227	DECORA Switch " MOM " White					30.00

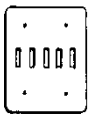

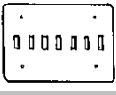
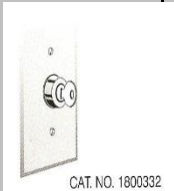
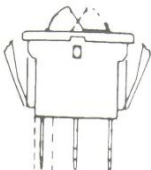

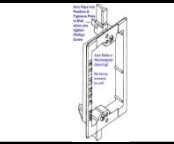



E 274	3-gang plate 5-cutouts						
E 275	4 gang plate 6 cutouts						
E 282	5-gang plate 7-cutouts						
E 283	5-gang plate 8-cutouts						
E 281	KEY SWITCH						
E 276	Arrow-Hart or Carlin Swi SPDT OFF						7
E 277	Push-On Lugs for Switches						0.15
E 238	1- Gang LOW VOLT Wall Mount Plate						

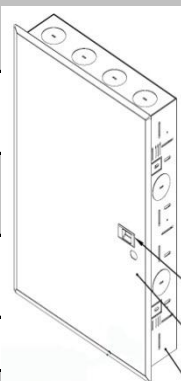





**CONTROL BOXES**

### FLUSH MOUNTED STRUCTURED WIRING PANE STRUCTURAL BOXES

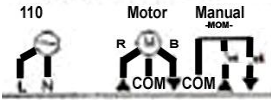
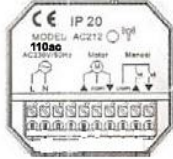
14 RPs	320-215		14.75	x 3 1/2			89
10 RPs	320-225		14.37	x 3/12			74
18 RPs	BW 315		14.37	x 3 1/2			70
24 RPs	320-230		14.37	x 3 1/2			149
	ICC		14	x 28			
32 RPs	320-240		14.37	x 3 1/2			194
10 RPs	Surface Control Box	<i>metal w</i>	11	x 4 1/2			29
							
E 249							5
E 217	Ctl Box White #250 3x6x2 (for RC1)						13
E 218	Ctl Box Beige for RC 2						61

### PLASTIC WORK BOXES

E 250	LP 35		<i>in-line / In-Lin</i>	4.25	x 3	x 1.3	8
E 279	DC-46FMBY/ Bone		RC 2	6.125	x 4.62	x 2.25	
E 280	DC-58F/03		RC 3	8.25	x 5.0	x3	
E 284	DC 85			8.25	x 5.0	x3	
E 285	DC 96			10	x 6	x3	
<b>PARTS ONLY for STOCKING DEALERS</b>					<b>21-30 pcs</b>	<b>11-20 pcs</b>	<b>1-10 pcs</b>
E 252	RF20 / AC 207		Receiver	<b>110 ac</b>	41.67	43.66	59.00

E 278	RF20+ PM2414TO Plug+F		4x 2.125x 1.4				
E 298	AC 212-01 UMC	 	Manual Inputs	1.8x2x1.8	75	82	92
E 298	AC 201-01 In Rail Receiver	Manual Inputs	4.2 x .42				
<del>E 253</del>	<del>RF04</del>	<del></del>	<del>Transmitter</del>	<del>1-function</del>			<del>17</del>
E 287	MJ 01						17
<del>E 288</del>	<del>MJ 04</del>	<del></del>					<del>21</del>
E 254	RF-05		Transmitter	5-function			21
<del>E 289</del>	<del>MJ 06 (fits RAEX ONLY)</del>	<del></del>	<del>Fits RAEX ONLY</del>				<del>21</del>
E 255	RF-15		Transmitter	15-function			54
1A	Trans Wh			1-function			19
4A	Trans Wh			4-function			19
E 298							
E 299							

E 300						
E 301						
E 301						
E 302						
E 303						
E 304						

AC 114 SERIES - TRANSMITTERS					31-50 pcs	21-30 pcs	11-20 pcs	1-10 pcs
E 293	AC114-01		transr	1-function			19.00	24.00
E 294	AC114-02		transr	2-function				
E 294	AC114-06		transr	6-function			23.00	28.00
E 295	AC114-16		transr	16-function			36.00	44.00
AC 123 SERIES - TRANSMITTERS - I-PHONE LOOK-					31-50 pcs	21-30 pcs	11-20 pcs	1-10 pcs
	AC 123-01			1-function				25.00
	AC 123-02			2-function				28.00
	AC 123-06			6-function				31.00



**AC 123-16**

16- function

44.00



**AC 123 - LCD**



Built In TIMER

**AC 121-01**

**AC 121-02**





**AC 121-06**





**AC 121-16**

AMERICAN STYLE WALL CONTROLS		31-50 pcs	21-30 pcs	11-20 pcs	1-10 pcs
E 295	#507-1 American Std Wall Switch 			25.87	32.34
E 296	#508-01 Am std Wall Insert receiv 			64.68	80.85
E 297	#509-01 Am Std Insert Radio Trans 6-function "WIRELESS" 			42.04	52.55
	#509-02 SpECIAL Contract 2-Function	17.14	18.94	19.84	25

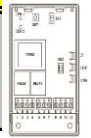
86-1 RF					69
86-2 RF					82
86-1D (RF)					69
86-2D (FWall Transmitter 2- Function					82
AC112 Surface Wal Tran ( OLD 	1 channel	#86-1B			22

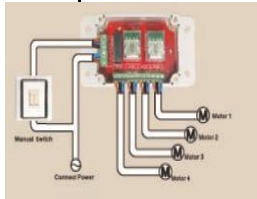

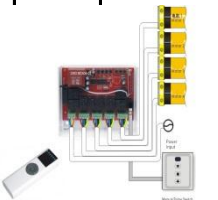
							
AC 112-2	LCD Surf Wall Trans		1 channel				
AC113	Surf Wal Tran (OLD 86-2E		2 channel	#86-2B			26
AC 117	RS 232-485 Interface - NO CABLES						135
AC 510	Surface Wall Trans- Wireless		1 Channel	18.70	20.66	21.65	27
AC 511	Surface Wall Trans- Wireless		2 channel	21.81	24.11	25.26	32
<b>GROUP CONTROL</b>				31-50 pcs	21-30 pcs	11-20 pcs	1-10 pcs
AT-01							63.00
aT -02							63.00
AT -03							79.00

AC 402	4- Motor Group Ctl by 110 AC 5.5 x 2.375						60.00		
AC 403	4-Group Motor Control by LV Interface 6.4x4.8x2						60.00		
AC404-0	4- Group + RF and ALL Feature (AT-04)						98		
<b>A-OK TUBULAR MOTORS 110 AC</b>					<b>31-50 pcs</b>	<b>21-30 pcs</b>	<b>11-20 pcs</b>	<b>1-10 pcs</b>	
Tubular	AM35-6/28 Tubular Motor 6 Nr	52#	<b>110 AC</b>	75.85	77.90	79.95	83		
Tubular	AM35 3/28E	16/ Cs	32#	112.2	118.4	124.6	138.1		
Tubular	AM35 6/28 <u>E</u>	16/ Cs	652#	118.3	121.5	124.7	128.9		
Tubular	110 AC	AM35 3/28 EL ELECTRONIC LI	32#						
Tubular	110 AC	AM35 6/28 EL ELECTRONIC LI	52#			129.4	143.3		
Tubular	110 AC	AM35 8/19 EL ELECTRONIC LIMITS				132.3	146.5		
Tubular	110 AC	AM45 10/30	10N						
Tubular	110 AC	AM45 20/30	8/ Cs	20	176#	97.1	99.7	102.3	106.0

Tubular 110 AC	AM45 30/17	8/ Cs	256#					147.0
Tubular 110 AC	AM45 10/30E	8/ Cs	88#	w/ Trans				206.0
	AM45 20/30 <u>E</u>	8/ Cs	176#	w/ Trans	136.5	140.2	143.9	148.6
Tubular 110 AC	AM45 30/17 <u>E</u>	8/ Cs	256#	w/ Trans			141.0	156.0

AM 45

				31-50 pcs	21-30 pcs	11-20 pcs	1-10 pcs
--	--	--	--	--------------	--------------	-----------	-------------

	ROUND DRIVE AM 35							2.05

S00213	ROUND DRIVE AM 45 Drive Adaptor AM 45							2.05

S00142	Octogon Collar AM35 Motor			1.56	1.72	1.80	2.80	

S00139	Octogon Adaptor AM 35							

<b>ADJUSTABLE MOTOR BRACKETS</b>								

Motor Bkt	2.06.001.194		SET		#####
IDLER Bkt	2.06.001.193				
TUBE - IDLER END	SS01623				5.92

A-OK QUIET MOTORS -Mechanical Limits"				31-50 pcs	21-30 pcs	11-20 pcs	1-10 pcs
	AM45 3-30 QUIET MOTOR	32#			93.48	95.94	99.4
	AM45 6-30 QUIET MOTOR	52#			96.6	99.14	102.7
	AM45 8-22 QUIET MOTOR	70#			96.6	99.14	102.7
S00197	2" round Drive Adaptor S00197						2

A-OK - SHADE HARDWARE							

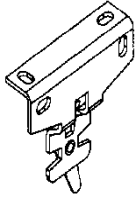
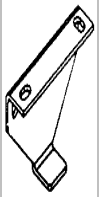
RB 360 Brackets	1 1/2" Projection						
RB 380 Brackets	2.0" Projection						2.5

	RB 390 Brackets	2 7/8" Projection					3
	Motor Plate						2
	End Cap for 40mm Round Tube						10
E 251	3-wire 18ga	Plug Cord White	6 ft				8
E 257	18/2 2-wire	Plug Cord White	8 ft				5
E 270	AC Plug White- RIGHT ANGLE-	WESPORT					5.02

### **DC POWER SUPPLIES**

DC power Supply	12 V	1 Amp	DCTX1216		20
DC Power Supply	12 V	3.33 Amp	PS-1233		47
DC Power Supply	12 V	7.5 Amps			
DC Power Supply	12 V	11 Amp (ESI)	OPEN FRAM	250	

### **SOMFY MOTORS & PARTS**

31-50 pcs	21-30 pcs	11-20 pcs	1-10 pcs
-----------	-----------	-----------	----------

					
Telis 6 Chronis RTS -Programmable Timer					393
Telis 1	1810632				54
Telis 4	1810633				69
Telis 16	1811020				225
RS 232 Wireless					
Universal RTS Interface	1810872				395
DB9 to RJ45 Adapter for RS 232	9015028				16

SAOMFY RTS Motors

ALTUS 506S2 Round Head	1037519		302
------------------------	---------	--	-----

Drives- Round	9206088		2.36
---------------	---------	--	------

<b>ADD-ON DRAPERY MOTORS</b>				31-50 pcs	21-30 pcs	11-20 pcs	1-10 pcs
Drive Tires 3/ Set						<b>27.04</b>	
<b>Sub Total of this Invoice</b>							
Packaging							
Freight							
<b>GRAND TOTAL DUE is</b>							

RETAIN TITLE CONTRACT. All GOODS remain property of LEG, until paid in full. Warranties on all equipment as applied by manufactures. All Equipment to Factory by CLIENT. No labor, freight or installation included. Any Collection or Legal action will take place in Miami, Florida, USA. ATTORNEY FEES, in the event it becomes necessary to resolve an order in Court, LEG is entitled to recoupe Legal Fees and Court costs as part of the Settlement. All action to be in Miami, Florida, County of Dade. Any Collection Charges will be additional on past due bills @ 1 ½ % per month. Any returned checks, for any reason, will incur a \$35 Processing fee. Any CREDIT CARD purchases made by customer are deemed to be by Card Holder. And permission is given for goods to be received at the address given, by anyone who signs. We DO NOT Redeposit checks. \*\*Typographical, clerical errors, or omissions in quotations= Subject to correction.\*Orders are considered CUSTOM and special parts and systems are made. We do NOT accept cancellations. Jobs that Drag on over 12-months- will incur additional expenses. NOTE. When dealing with shades over certain widths, FABRIC is seamed as standard manufacturing practices. SHIPPMENT TERMS= "Shipment Contract". once consigned = Customer assumes responsibility for goods

Ordered as standard manufacturing practices. On H + M ERM Terms - Shipment Contract, once consigned - Customer assumes responsibility for goods

This INVOICE must be signed to be entered as your order... Please sign and return Copy to LEG

ACCEPTED BY

DATE:











































































































